

# GIRA

Smart Home.  
Smart Building.  
Smart Life.

Space for a new  
way of thinking.

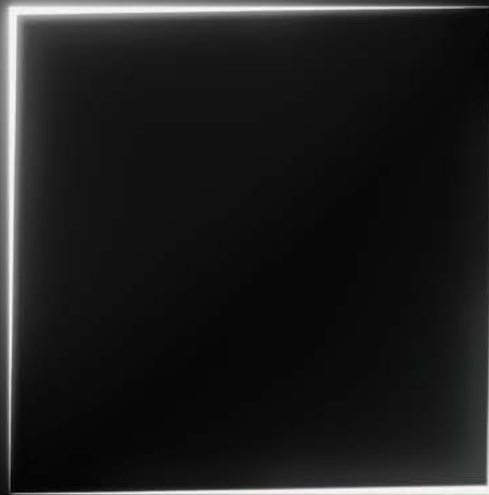

Gira / New products

We are Gira.  
We are the ones with the switches.  
But we're so much more.

Future-oriented.  
Certified.  
Responsible.

We're the guardians, innovators,  
smart home pioneers, developers,  
system experts, KNX partners,  
shapers of the future, patent masters,  
award winners and designers.

But above all, we're the ones  
who listen.  
To you.

Subtle, but smart.  
With distinct focus on quality,  
materials and functions.  
And the driving force of innovation.

In our hearts, we are engineers  
on a mission to inspire.  
With new technologies,  
smart applications, and  
impressive attention to detail.

We will always work our hardest  
to find the best solution for you.  
With service, design and performance  
made in Germany.

Because that is what we stand for.  
And have been standing for since 1905.

---

04 \_\_\_\_\_ Introduction

06 \_\_\_\_\_ Design & function

24 \_\_\_\_\_ Smart Home

36 \_\_\_\_\_ Door communication

42 \_\_\_\_\_ Services

46 \_\_\_\_\_ Company

New products / Introduction

Breaking new  
ground together.

An abstract graphic design featuring a dark background. A prominent white, glowing V-shaped line is positioned in the lower right quadrant. This line is surrounded by a soft, multi-colored gradient that transitions from yellow and orange at the bottom to green and blue towards the right. The overall composition is minimalist and modern.

We give space to new ideas.  
Every day.

We rethink production processes. To ensure a good workplace for our employees. We regularly scrutinise our product range, checking it for quality and durability. We see it as our task to constantly develop it further, to question and optimise the tried and tested. Sustainability and future viability are important aspects. So are easily realisable smart home systems that provide greater convenience, security and energy efficiency. All of this because we want satisfied customers who, at best, will favour us for the rest of their lives. We seek proximity to our specialist partners in order to provide them with the best possible support.

We also want to be No. 1 for you. That's why we not only offer a well thought-out, high-quality full range of products, but also constantly update and expand our services for your everyday work. Stay tuned for our innovations and let us convince you again and again. We are a manufacturer of switches – but also much more.

# Design and functionality with a vision.

For 25 years, Gira System 55 has stood for innovation, versatility and sustainability in modern building technology. Thanks to constant development, the modular system offers extensive freedom of design. Over 300 functions can be combined with a wide selection of design lines. If our customers' wishes change, the Gira System 55 is flexible enough to adapt and always enables a customised installation solution. Design and function have always been really important to us, just like the quality and durability of our products. As a general rule, mechanical Gira products are designed to have an average service life of 20 years.

---

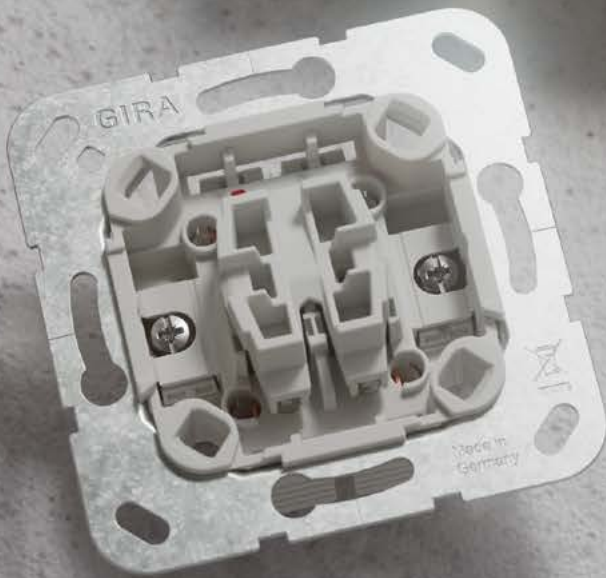



## The new generation of Gira switches.

Versatile new features down to the last detail.

Making a good thing better: The new generation of Gira switches has been completely revised with numerous improvements that go right down to the finest details. The result is fewer products, but with more combinable functions. The existing switch range will be entirely

replaced – from the Gira System 55 and Gira TX\_44 to the Gira F100, as well as both the water-protected and dry surface-mounted design lines. The switches are manufactured in Germany to the highest quality standards, far in excess of the required VDE standards.





**Simplified installation.  
Improved handling.**

In changing the structure of the switching inserts, our aim was to facilitate and accelerate the installation steps and work processes. A key new feature is the integrated rocker holder.

For more information, see  
[partner.gira.com/newswitchgeneration](https://partner.gira.com/newswitchgeneration)

---

⊕ Highlights, facts and benefits of the new generation of Gira switches:

---

Optimal use of space with the single rocker holder for the rocker switch, rocker button and pushbutton switch.

More convenient installation.

A full range of pushbutton switch products are now also available – for more flexibility and combination options.

Available in all Gira System 55, Gira F100 and Gira TX\_44 colours.



---

**More precision, a more pleasant feel.**

A flatter switching angle and the optimised gap between rocker and cover frame give the design line an even more premium look. Manual actuation also has a noticeably more pleasant feel.

Available from:  
**08/2024**

LED colours  
available:

-  01 orange (standard)
-  02 red
-  03 white



Standard LED lighting element can be inserted from the front



Depending on the switch, the lighting element can be rotated by 180° to switch between standby and continuous illumination

Simplified installation in the flush-mounted device box with recessed expanding claw



Easy-to-install, shallow base installation depth (only 28 mm with conductors or 23 mm from support ring to lower base section)

Easier installation and alignment of the switching inserts one below the other thanks to an enlarged claw spread dimension (71.3 mm)



Easily accessible release lever

Shatter-proof thermoplastic base

Article no. 311200

Floating switch rocker allows automatic and precise positioning of the rocker in the cover frame

Quick mounting (3.5 turns per mounting claw)

Easier claw mounting thanks to robust PZ1/slotted/PH screw head drive

Voltage check possible from the front

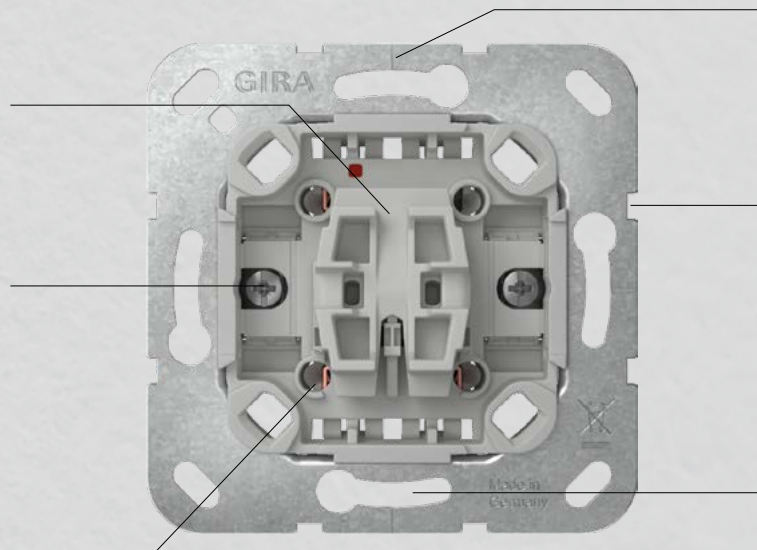

Markings for central alignment with several flush-mounted inserts

Levelling aid for multi-gang installation

Large keyhole profiles in the patented opposed layout so that the insert can be easily aligned even if the flush-mounted device boxes are not installed properly

Article no. 310600

The base is marked by high-contrast, easy-to-read laser inscriptions

Conductor insertion from the rear

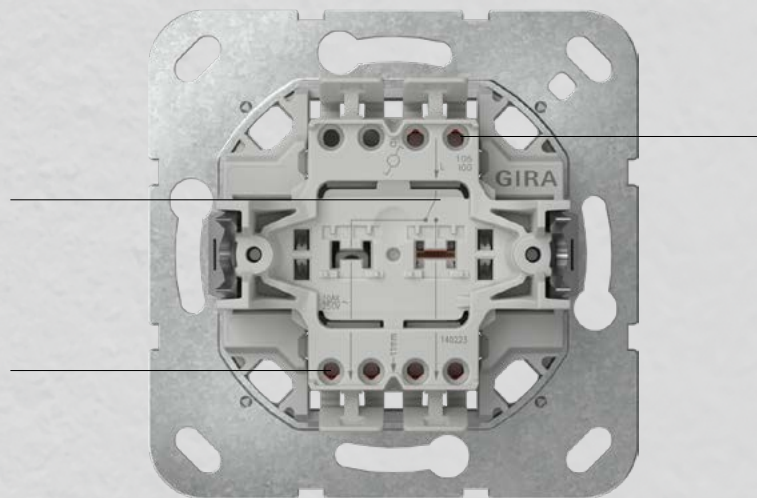

Uniform stripping length (11 mm) for switches and socket outlets guarantees quicker and more efficient mounting

Rigid and flexible conductor materials can be used

Article no. 310600



**Highlights, facts and benefits of the new generation of Gira switches:**

Floating mounting of the rocker holder automatically centres the rocker in the cover frame in an optimal fashion.

Uniform circumferential gap between rocker and cover frame.

Pleasant switch feel thanks to a flatter switching angle for increased perception of quality.

LED lighting element can be inserted from the front.

# The new generation of Gira socket outlets.

Further refined for even more convenience.

With new detailed solutions and subtle structural changes, the new generation of Gira socket outlets is here. Benefit from more protection and simpler handling. With the same basic design, a total of five socket outlet types are available for flush-mounted, surface-mounted and duct installation. All designs are easy to handle during installation and have the high quality expected of "Made in Germany" products. The socket outlets are manufactured in Germany to the highest quality standards, far in excess of the required VDE standards.

For more information, see  
[partner.gira.com/socketoutlets](https://partner.gira.com/socketoutlets)

Available



---

⊕ Highlights, facts and benefits of the new generation of Gira socket outlets:

---

For greater safety, the support ring is now earthed in combination with the mounting claws and claw screws and is therefore integrated into the protective measure.

Backward compatibility allows old and new bases and covers to be combined (except for socket outlets with an earth pin).

---

Sturdy earth bar with solid spring fingers

Quick mounting (3.5 turns per mounting claw)

Easier claw mounting thanks to robust PZ1/slotted/PH screw head drive

Levelling aid for multi-gang installation

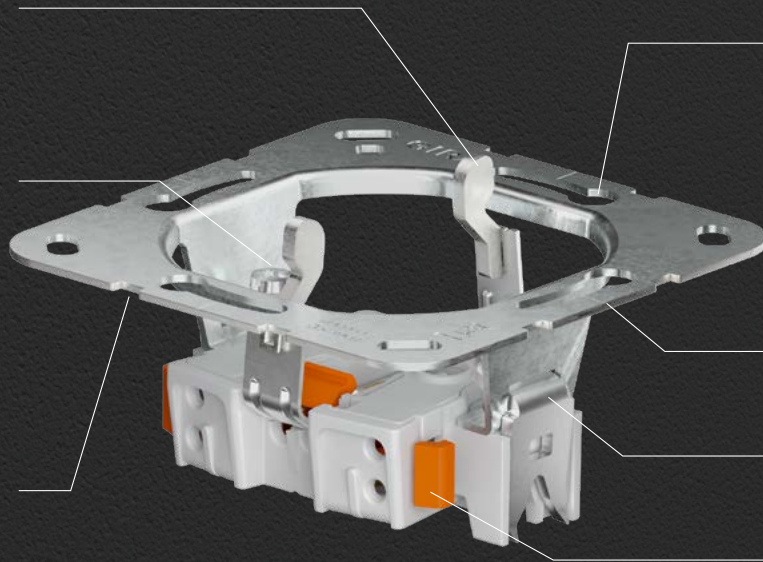

Large keyhole profiles in a patented layout

Marking for centred alignment for multiple installations

Expanding claws in the housing

Large, ergonomically shaped release levers

- 01 SCHUKO socket outlet with plug terminal
- 02 SCHUKO socket outlet with screw terminal
- 03 Socket outlet with earth pin (CEBEC) and plug terminal
- 04 Socket outlets without protective contact and plug terminal
- 05 Danish socket outlet with plug terminal

01



02

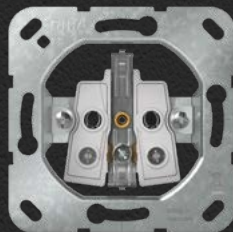

03



04



05



# The new Gira F100.

New details and functions reveal true greatness.

The Gira F100 has been technically adapted into a streamlined full range which, with its puristic, minimalist design, now offers a true alternative to the Gira System 55 on both an aesthetic and functional level. All switch covers and socket outlet covers have been

technically redesigned. The new rocker design is characterised by a smaller gap and a flatter switching angle. In addition, new functions have been integrated into the range, such as blind and heating top units for the Gira System 3000, the Gira IP flush-

mounted radio, the Gira pushbutton sensor and KNX RF button.

For more information, see [partner.gira.com/f100](https://partner.gira.com/f100)

Available from:  
**08/2024**



## Highlights, facts and benefits of Gira F100:

---

The large operating surface puts function in the spotlight.

Simple, puristic, minimalist

Made from high-quality, shatter-proof thermoplastics.

High-gloss, easy-to-clean surface.

Large product range.

---



# Simple, puristic, minimalist.



- 01 Pushbutton switch with rocker, 1-gang
- 02 Pushbutton switch with rocker, 2-gang
- 03 Pushbutton switch with control window, 1-gang
- 04 Pushbutton switch with control window, 2-gang
- 05 SCHUKO socket outlet 16 A 250 V~ with shutter
- 06 SCHUKO socket outlet 16 A 250 V~ with inscription space
- 07 Socket outlet with earth pin 16 A 250 V~ and shutter
- 08 SCHUKO socket outlet 16 A 250 V~ with hinged cover
- 09 System 3000 blind timer and timer display
- 10 System 3000 room temperature controller BT
- 11 System 3000 operating top unit BT arrow symbols
- 12 System 3000 blind timer and timer BT arrow symbols
- 13 Button with rocker, 1-gang, arrow symbols for Gira One and KNX
- 14 Button with rocker, 2-gang, arrow symbols for Gira One and KNX
- 15 RF operating top unit, 1-gang, for KNX
- 16 RF operating top unit, 2-gang, for KNX
- 17 Pushbutton sensor 3 Komfort, 1-gang, for KNX
- 18 Pushbutton sensor 3 Komfort, 2-gang, for KNX
- 19 Pushbutton sensor 3 Komfort, 4-gang, for KNX
- 20 Pushbutton sensor 3 Plus, 2-gang, for KNX





01



02



03



04



05



06



07



08



09



10



11



12



13



14



15

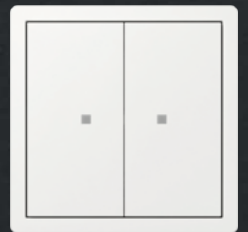

16



17



18

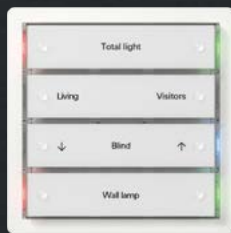

19



20

New products / Design & function



# Gira E1.

## Minimalist and natural.

The new design line from Gira System 55 has an unobtrusive natural look. The design is minimalist but nevertheless expressive with its soft contours. Simple, neutral, striking in its detail – the Gira E1 is suitable for almost any environment.

For more information, see  
[partner.gira.com/e1](https://partner.gira.com/e1)

Available from:  
 09/2024

---

### ⊕ Highlights, facts and benefits of Gira E1:

---

Understated but striking design.

Can be used for over 300 functions from Gira System 55.

Available in different colours.

---



01



02



03



04

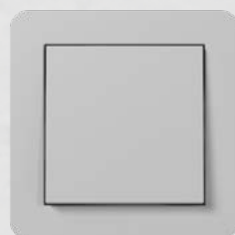

05

#### Colour versions:

- 01 pure white glossy
- 02 pure white matt
- 03 anthracite
- 04 black matt  
(lacquered)
- 05 grey matt  
(lacquered)

# Gira E2 light grey in recycled material.

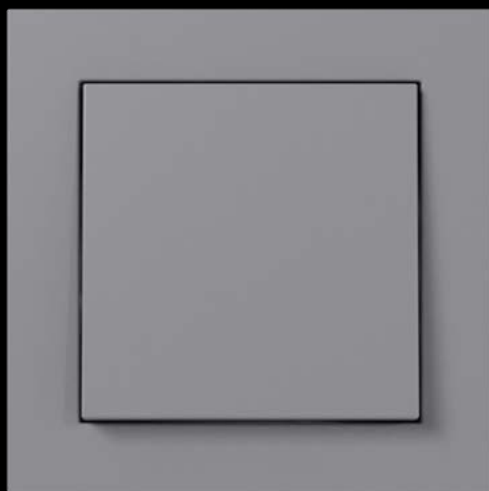

Sustainable design line made from recycled material.

The new colour variant Gira E2 light grey is the right choice for customers with increased environmental awareness. The plastic parts of the design line consist primarily\* of recycled materials which have a carbon footprint reduced by around 54% in comparison with new materials\*\*. A large number of functions from the Gira System 55 are available in the light grey colour upon request.

The Gira E2 in aluminium and grey matt are also partially made from recycled materials. As usual, these colour variants are listed in the catalogue as a complete range, with over 300 functions.

For more information, see [partner.gira.com/e2](https://partner.gira.com/e2)

Available:  
upon request



Highlights, facts and benefits of  
Gira E2 light grey in recycled material:

Saves resources and reduces CO<sub>2</sub>.

Produced in-house from recycled materials.

\*Only the socket outlet cover and additional components, such as transparent inscription spaces, are made from new materials.

\*\*This reduction was determined on the basis of an ecological assessment pursuant to ISO 14040 of a 1-gang plastic cover frame.

# Gira overvoltage protection module.

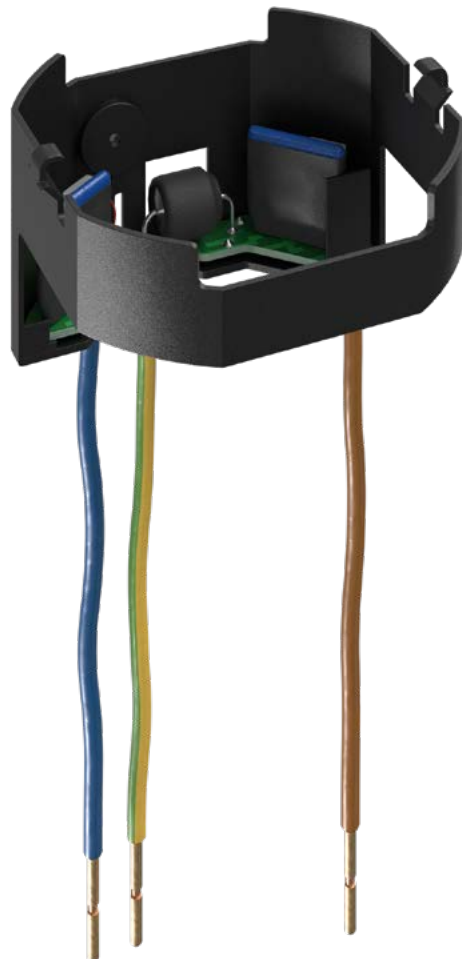

Retrofittable protection against short-term voltage peaks.

To protect electrical equipment against transient surges, the Gira overvoltage protection module can be easily retrofitted to most socket outlets. The ring module is plugged into the back of the socket outlet and can also protect other socket outlets to which the cable length is less than 10 metres. Thanks to the compact design, there is ample wiring space in the device box.

For more information, see [catalogue.gira.com](https://catalogue.gira.com)

Available from:  
03/2024

---

⊕ Highlights, facts and benefits of Gira overvoltage protection module:

---

Versatile – can be attached to almost all socket outlets.

The tight-fitting ring module creates enough space for wiring and facilitates installation.

Integrated button tone if there is a fault with the socket outlet.

3 kA discharge capacity.

---

# Gira System 3000 motion detector top unit.

## Simple light automation.

The Gira System 3000 makes it easy to smartly control individual functions in the room, such as the lights. New to the range is the Gira System 3000 motion detector top unit 1.1 m Standard with delay time. This can be individually adjusted between 10 seconds and 30 minutes as required.

For more information, see  
[partner.gira.com/system3000](http://partner.gira.com/system3000)

Available



Highlights, facts and benefits of the Gira System 3000 motion detector top unit 1.1 m Standard with delay time:

---

Delay time and brightness threshold can be individually adjusted.

Can be activated for daytime operation irrespective of brightness.

Different adjustment and application options.

The range of detection can be individually extended.

Can be combined with all Gira design lines.

---



# Innovative solutions for intelligent building technology.

Gira Smart Home Systems are the future of building technology, because smart controls help to save on energy costs, increase home comforts and boost house prices. Thanks to the numerous customisation options, Gira can provide the ideal solution to any desire and equipment demand.

Simple and intuitive operation of switches, apps or other devices is just as important to us as the future viability of our systems. We use globally established standards and always keep our products at the cutting edge through regular updates. Our systems are compatible with one another, so that they can be flexibly extended at any time and can be adapted to different requirements.

The operating devices of our systems are securely protected against external access and tampering. Typical of Gira, they also impress with high-quality materials and a large selection of outstanding designs.

Discover our smart home systems in the video:







# Pushbutton sensors now also available for Gira One.

Excellent feel, outstanding design.

From May 2024, you can offer your customers even greater versatility of design in the Gira One – System and be more flexible with your customer support: The Gira pushbutton sensor 4 System 55 (Komfort) and the Gira pushbutton sensor 4 (external dimensions 95 × 95 mm) will then also be available for Gira One Smart Home Systems.

Countless functions can be operated with two pushbutton sensors, creating modern, attractive smart homes in which technology takes a back seat. This saves costs and time with installation. Gira pushbutton sensors can be individually inscribed for intuitive operation of a wide range of functions.

The system can be started up as usual via the Gira Project Assistant (GPA): quickly and easily. Step-by-step instructions with an integrated training video take you through the work process. Gira One is based on the KNX Secure standard and thus offers a high level of reliability. We also guarantee this high level of reliability with each new software release: because Gira One is tested in automated infinite loops.

For more information, see [partner.gira.com/gira-one](https://partner.gira.com/gira-one)

Available from:  
**05/2024**



Get to know Gira One in the video:



---

⊕ Highlights, facts and benefits of Gira One:

---

High-performance Smart Home System: With light, shading and temperature control.

Easy and quick start-up with Gira Project Assistant.

Reliable thanks to the KNX Standard.

Protected against hackers thanks to the KNX Secure.

Outstanding, versatile design with Gira pushbutton sensor 4.

---

01  
Gira pushbutton sensor 4



02  
Gira pushbutton sensor 4  
System 55



Customise Gira  
pushbutton sensors  
with the Gira  
inscription service:

[marking.gira.com](http://marking.gira.com)

One

Compatible with Gira



Compatible with  
KNX Secure:  
[partner.gira.com/  
knxsecure](http://partner.gira.com/knxsecure)

# Smart Energy.

Create added value with smart energy management.

Gira Eco allows you to integrate electric mobility easily and securely into your Smart Home. Up to five manufacturer-independent wall boxes can be integrated into the KNX system. Thanks to dynamic load management, it protects the household connection against overload: The charging current is prioritised and automatically reduced if necessary.

For more information, see [partner.gira.com/eco](https://partner.gira.com/eco)

Available from:  
Q3/2024



---

⊕ Highlights, facts and benefits of Gira Eco:

---

- Dynamic load management.
  - Static load management.
  - Support for five charging points
  - Manufacturer diversity and combined operation.
  - Connection via IP or RS485 (Modbus).
- 



Compatible with  
KNX Secure:  
[partner.gira.com/  
knxsecure](https://partner.gira.com/knxsecure)



### Everything at a glance.

With the Visu module from Splendid Minds GmbH, all the values available in the KNX system, such as energy data, can be visually presented. The module enables graphs and diagrams to be depicted on the Gira Smart Home App. In this way, the power generated by photovoltaic installations or electricity consumption can be displayed.

For more information, see [splendidminds.de](http://splendidminds.de)

Available

### More data. Greater possibilities.

For greater flexibility, Gira offers a Modbus logic node for the Gira X1. This allows additional energy data to be retrieved from other charging stations, PV installations, battery storage, heating rods and heat pumps and integrated into the KNX system.

For more information, see [download.gira.com](http://download.gira.com)

Available

The Modbus module is available via Gira download; the visualisation module can be purchased from the Splendid Minds GmbH app store.



## DALI gateway colour for KNX.

Create atmosphere with colourful light.

The DALI Gateway Colour for KNX easily switches and dims white and coloured DALI 2-based lighting. It is available in 1-gang or 2-gang versions for up to 124 DALI operating devices. In addition to the extensive options for light colour control (DALI device type 8), there are now also convenient Human Centric Lighting functions which are a very user-friendly way to adapt the lighting individually and dynamically as required.

For more information, see [partner.gira.com/dali-gateway-colour](http://partner.gira.com/dali-gateway-colour)

Available





Highlights, facts and benefits of the DALI gateway colour for KNX:

HCL Human Centric Lighting: Pleasant, healthy light control, e.g. for the health care sector.

Space-saving DRA installation thanks to compact design: 1-gang or 2-gang for up to 128 lights.

Dynamic lighting control via Colour Transition Mode.

Supports broadcast, group and individual control and a combination of group and individual control.

Very simple and time-saving start-up, including offline, possible prior to the installation of the DALI lights.



Compatible with  
KNX Secure:  
[partner.gira.com/  
knxsecure](https://partner.gira.com/knxsecure)

Discover the DALI  
gateway colour for  
KNX in the video:



# Button interface for KNX



Easily integrate more operating functions.

KNX Secure button interfaces enable the integration of conventional products with zero-voltage contacts into the KNX system. These include, for example, conventional buttons and switches for manual actuation and reed contacts for assessing window status. Depending on the variant, up to 30 m of zero-voltage contact line can be covered up. The new button interfaces for KNX are available in 2-gang, 4-gang or 8-gang versions and offer numerous functions for plenty of flexibility at an attractive price.

For more information, see  
[partner.gira.com/KNX-button-interface](https://partner.gira.com/KNX-button-interface)

Available from:  
03/2024

---

⊕ Highlights, facts and benefits of the  
KNX Secure button interface:

---

Six product variants – 2-gang/4-gang/  
8-gang – each available in Standard and  
Komfort designs.

Automatic removal of oxide layer on the  
connected contacts.

Combining adjacent channels for  
the button and door/window contact  
functions.

Temperature measurement via the  
Gira remote sensor.

Assessment by the leakage and  
condensation sensors.

Connection cables with ferrules to simplify  
installation.

Depending on the product variant, the  
cable length can be increased to up to  
30 m.

---



Compatible with  
KNX Secure:  
[partner.gira.com/  
knxsecure](https://partner.gira.com/knxsecure)



# Phase busbar for switch/ blind actuators for Gira One and KNX.

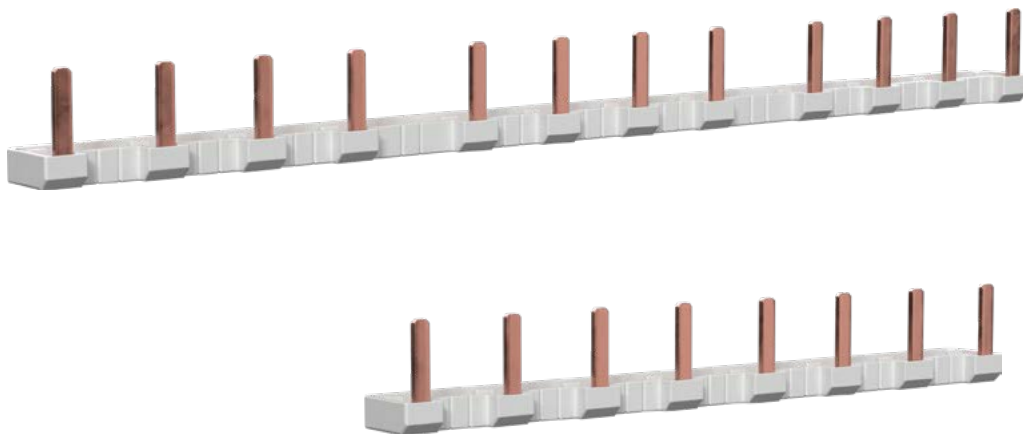

## Safe and clean actuator connection.

The phase busbars facilitate installation of switch/blind actuators for Gira One and KNX. If the same outer conductor is switched on several adjacent switching channels of an actuator, the wire bridges normally used are replaced by a phase busbar. This reduces the cabling in the switching cabinet, prevents faults and speeds up the installation.

For more information, see [catalogue.gira.com](http://catalogue.gira.com)

Available from:  
06/2024

---

⊕ Highlights, facts and benefits of phase busbar for switch/blind actuators for Gira One and KNX:

---

Significant reduction in wiring effort.

Quick and easy installation on the actuators

Can be flexibly shortened.

Available for switch and blind actuators 16/8 and 24/12.

Firmly fitted end caps for reliable contact protection.

Compact, space-saving design.

---

# Area/line coupler for KNX.

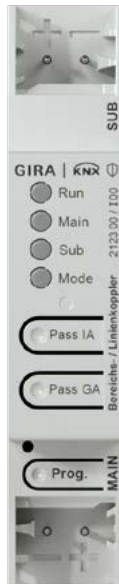

Highest level of security on all lines.

The area/line coupler for KNX allows cross-line communication between KNX devices. KNX Secure ensures reliable, secure communication. If non-secure devices are used, they can be easily integrated into KNX Secure systems using the Secure Proxy function. In larger installations, the new segment coupler function makes structuring much easier. In addition, the latency times for KNX telegram processing have been greatly reduced, which means commissioning and updating take much less time.

For more information, see [catalogue.gira.com](https://catalogue.gira.com)

Available from:  
**06/2024**



Highlights, facts and benefits of area/line coupler for KNX:

New compact design with a TE enables space-saving installation in the switching cabinet.

Considerably reduced ETS start-up times in larger installations.

Supports KNX data secure proxy function for cross-line group communication between KNX devices that use KNX data secure and devices that do not use it.

Can be updated.



Compatible with  
KNX Secure:  
[partner.gira.com/  
knxsecure](https://partner.gira.com/knxsecure)

# Gira F1 as a KNX bridge.

Reliably connect self-contained KNX installations to one another.

Gira F1 connects multiple separate KNX installations as a KNX bridge. The module enables KNX telegrams from shared sensors, such as a weather station, to be forwarded to the private KNX system in the apartment, among other things.

In addition, messages about pending maintenance or cleaning work in the apartments, for example, can be shown on a display. The Gira F1 is suitable for use, for example, in shopping centres with individual shops or if self-contained KNX systems are required to communicate with each other in company buildings that have grown over time.

For more information, see [partner.gira.com/giraf1](https://partner.gira.com/giraf1)

Available from:  
Q1/2024



Compatible with  
KNX Secure:  
[partner.gira.com/  
knxsecure](https://partner.gira.com/knxsecure)

Find out more about  
the functions and  
advantages of the  
Gira F1 in our video:



Highlights, facts and benefits of  
Gira F1 as a KNX bridge:

Couples several self-contained  
KNX systems as a KNX bridge.

Supports KNX Secure.

Can adapt group addresses to the  
KNX systems.

Start-up using the ETS.

# Welcome guests safely and in style.

Design and function – both play an important role at the front door. Firstly, the welcome at the front door creates the first impression. Secondly, the door communication system provides effective protection against unwanted guests. Gira's large modular range fulfils every wish, regardless of whether it is a traditional intercom system for detached houses and apartment buildings, with or without a camera, or whether it is equipped with mobile operating options via smartphone. Discover new technical possibilities, more data security and the elegant Gira System 106 in a new colour variant.





# Gira F1 for SIP door intercoms.



Secure segmentation of building and private networks.

In larger door communication systems, the participants are connected via the network-based SIP communication. In combination with the Gira F1 module, this guarantees secure segmentation of the building network and the private network used in the individual residential units. If the doorbell rings, only the corresponding video door call of the door station is activated in the private network and forwarded to the home station, e.g. the Gira G1. All other IP connections and access remain disabled.

For more information, see [partner.gira.com/giraf1](https://partner.gira.com/giraf1)

Available from:  
Q1/2024

---

⊕ Highlights, facts and benefits of the Gira F1 for SIP door stations:

---

Security through systematic segmentation of the networks.

Provides protection against access to the private network.

Supports SIP and SIPS.

Easy, browser-based start-up.

---

Find out more about the functions and advantages of the Gira F1 in our video:



# Gira DCS IP gateway.



See who's at the door from anywhere in the world.

The gateway release is fitted with a new, powerful main processor with faster memory and offers a high level of compatibility when using IP cameras. In combination with the Gira DCS IP gateway, the Gira door communication system can also be operated from elsewhere or at home using a smartphone: see the visitor at the front door, talk to them and even open the door – you can do it all with ease. The practical Gira door communication configurator can help to select suitable system devices.

For more information, see [partner.gira.com/dcs-ip-gateway](http://partner.gira.com/dcs-ip-gateway)

Available

## ⊕ Highlights, facts and benefits of the Gira DCS IP gateway:

Easy integration of IP cameras with customary h.264 standard.

A more powerful main processor and fast memory modules.

Allows integration of the Gira G1, computers, IP cameras and SIP telephones into the Gira door communication system.

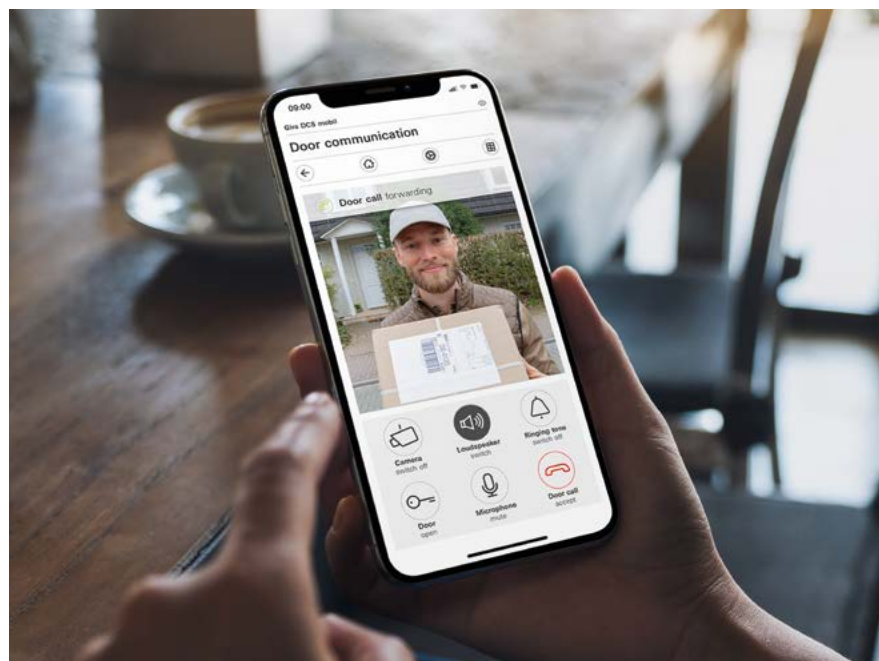



Kevin Snyder

Lauren Anderson

Frank Miller

Susanne Smith



# Gira System 106 black matt.

Modern look, robust quality.

Even more choice: The modular Gira System 106 offers countless functional modules which can be combined to suit any requirements. Even during installation, it is possible to choose between flush façade and simple surface mounting. The range has now been expanded to include the elegant, timeless black matt colour. Offer your customers the ideal solution to their every need.

For more information, see  
[partner.gira.com/system106](http://partner.gira.com/system106)

Available



Highlights, facts and benefits of the Gira System 106 black matt:

---

New, particularly attractive colour in the design system.

Durable powder coating.

Matt, particularly scratch-resistant surface structure.

---

# It's good to know what's important.

We regularly examine and supplement our service offers, in order to effectively support you in your everyday work. These include well thought-out, practice-orientated professional tools, training and educational sessions as well as opportunities to exchange information. Through regular newsletters, we keep you informed about new products, standards, training sessions and events. We are happy to provide you with technical support via hotline or on site. Benefit from our offers. Make your everyday work easier, save time and increase satisfaction among your customers.

---

# Gira Project Assistant.

The user-friendly Gira Project Assistant provides valuable services when creating a specific KNX visualisation, implementing a Gira One system or commissioning the Gira door communication system. Using the GPA, the project can be easily drawn up in an office, even if the devices are not present. Later, on site, the GPA project can easily be transferred to the devices using a laptop. The software is available on the Gira website free of charge: [download.gira.com](https://download.gira.com)

Available in: DE, EN,  
NL, ES  
IT available from  
05/2024

For more information, see  
[partner.gira.com/gpa](https://partner.gira.com/gpa)

GPA version 5.1 – available from 05/2024

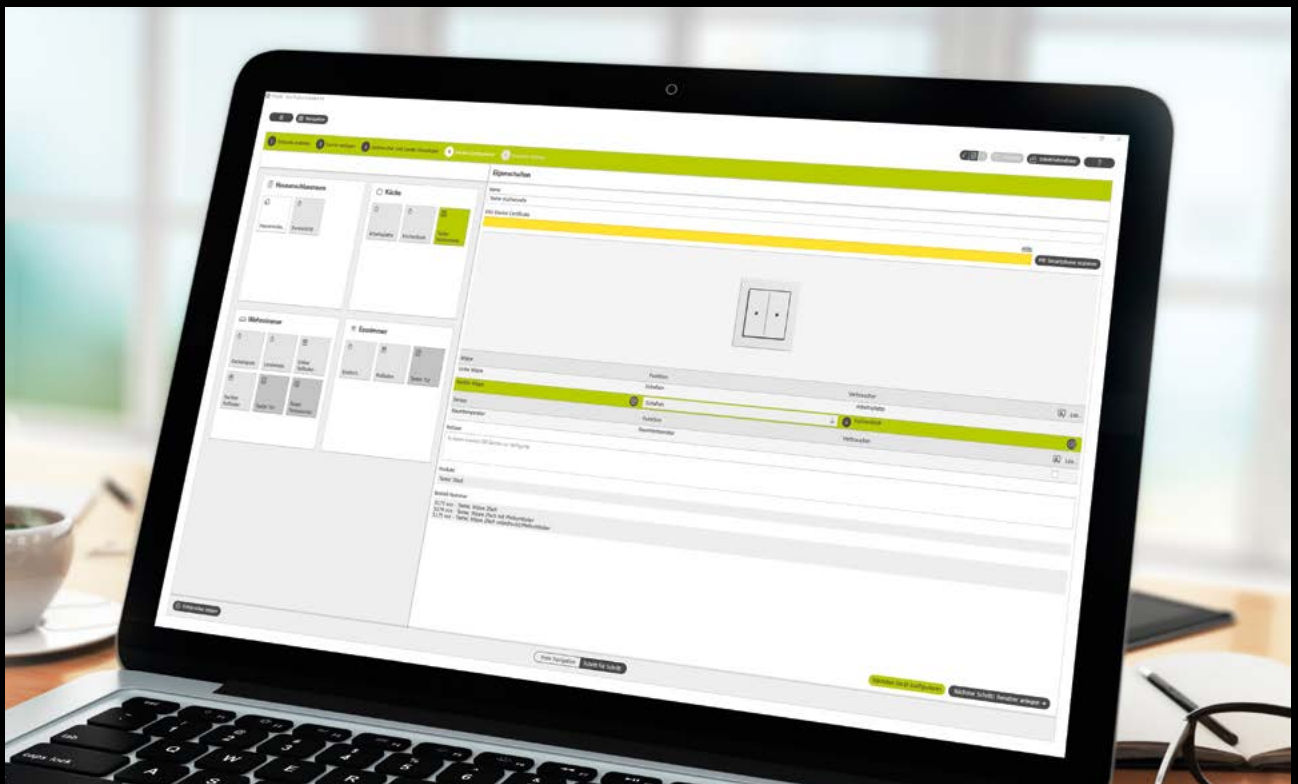

### Gira online catalogue.

Discover the complete Gira product range, from switches to intelligent system solutions. With the Gira online catalogue, you can also compare products, use the intelligent search function, manage parts lists and use the Elbridge interface to transfer them directly to the shopping cart of many wholesalers.

For more information, see [catalogue.gira.com](http://catalogue.gira.com)

Available in: DE, EN, NL, BE, ES, IT, PL, RU, NO, SE

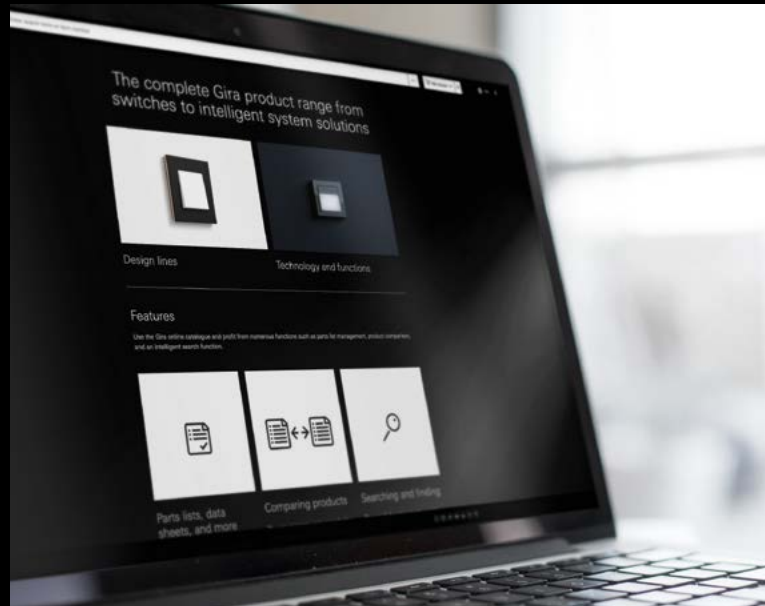

### Gira Academy.

A thorough understanding and comprehensive knowledge of the requirements of current and future Smart Home technologies will make your professional activity considerably easier. At the Gira Academy, your teachers will offer a variety of practice-oriented opportunities for your professional development in the fields of professional trade, planning and architecture. This training also includes online and face-to-face seminars such as web-based training, living events and hybrid formats in German and English.

For more information, see [academy.gira.com](http://academy.gira.com)

Available in: DE, EN, NL, partly in ES

### Gira Design Configurator.

Would you like first-hand experience of Gira products? Thanks to augmented reality you can experience the look of the Gira design lines in a real environment. Simply download the post-it with the QR code in the design configurator, attach it to the wall and follow the instructions in the app.

For more information, see [designconfigurator.gira.com](https://designconfigurator.gira.com)

Available in: DE, EN,  
NL, RU, CN, ES

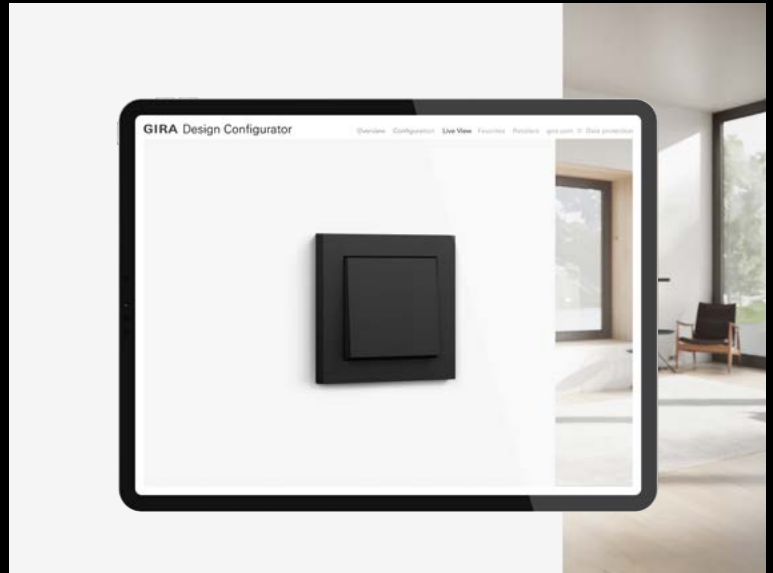

### Gira inscription service.

Use the service for clean and consistent inscription of numerous operating elements and door communication products.

For more information, see [marking.gira.com](https://marking.gira.com)

Available in: DE, EN



### Gira returns tool.

Return faulty devices without issue and request a replacement.

For more information, see [partner.gira.com/service/returns](https://partner.gira.com/service/returns)

Available in DE, INT

# Being innovative means thinking beyond your own four walls.

Since 1905, we've been the ones with the switches, but we're so much more ... Because innovation is our great passion. Our pioneering spirit drives us to constantly improve and enhance the comfort of people's homes with innovative solutions.

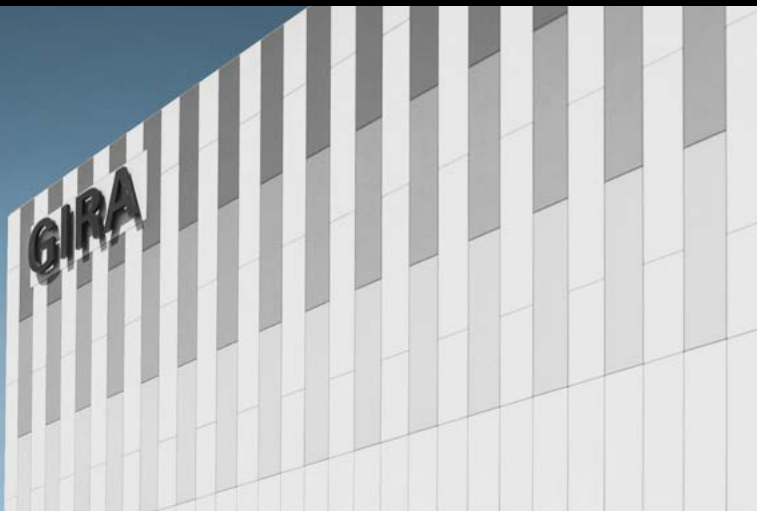

"Made by Diversity".

Gira has been manufacturing products at its location in Radevormwald for more than 100 years. The company is fully committed to the "Made in Germany" quality standard. This is what 1,250 employees from 27 nations work for – each and every one of them with different talents, individual expertise, wide-ranging experiences and different life stories. This diversity – supported by shared values – provides the basis for our creativity, innovative strength and future viability.

Innovative technology,  
award-winning design.

We have always aspired to combine maximum functionality and reliability with a unique design to create special user experiences. The extraordinary design quality and functionality of our products have been recognised by many internationally acclaimed awards.



Published by:  
Gira Giersiepen GmbH & Co. KG

Picture credits:  
Illustrations on page 57 above  
schmitz Visuelle Kommunikation  
hgschmitz.de

Subject to technical modifications.

Any colour variations between the illustrations in this product information and the product are due to printing processes and cannot be avoided.

For us, helping to shape the future means taking sustainable business practices seriously in all areas of the company. This brochure is another way in which we are contributing to this by managing the resources we need responsibly and using environmentally compatible materials. For example, the paper grades used are FSC® certified and made of at least 60% recycled paper. Printing is climate-neutral.

[sustainability.gira.com](http://sustainability.gira.com)



# GIRA

Gira  
Giersiepen GmbH & Co. KG

Dahlienstraße  
42477 Radevormwald

P.O. Box 12 20  
42461 Radevormwald  
Germany

Phone +49 2195 602-0  
Fax +49 2195 602-119

[www.gira.com](http://www.gira.com)  
[info@gira.com](mailto:info@gira.com)

---

Order no. 18264 90 01/2024 4, 22